

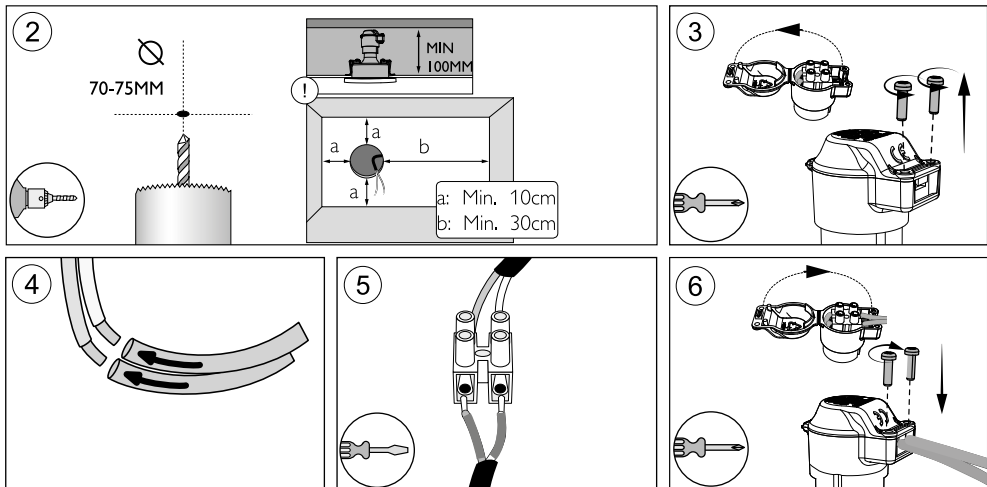

PHILIPS

Signify
I.B.R.S. / C.C.R.I. Numéro 10461
5600 VB Eindhoven,
the Netherlands
00800-74454775

440402911571 Last update: 02/05/19

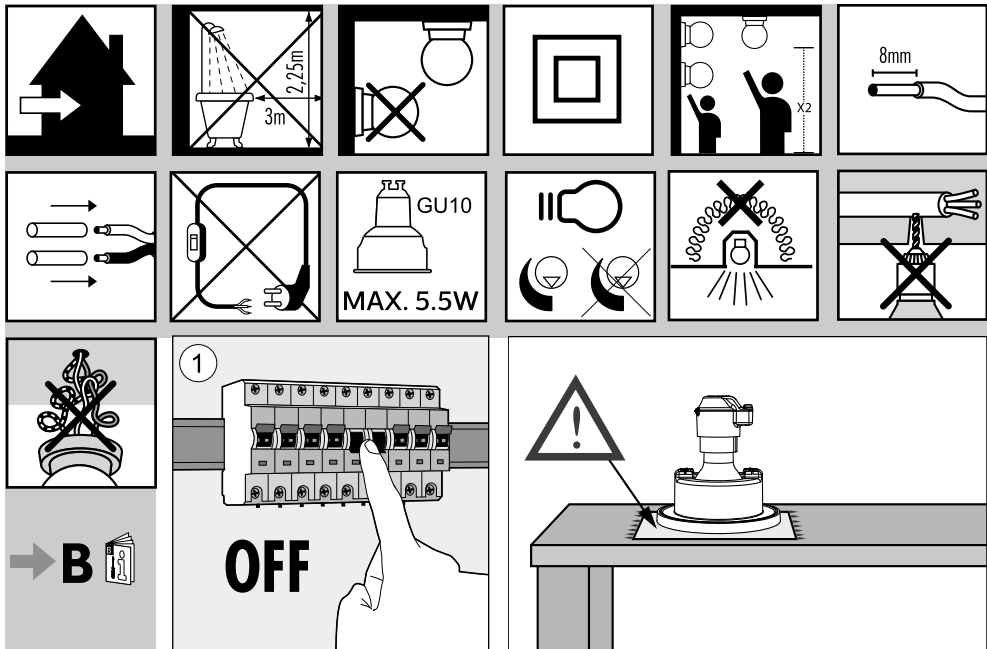

PHILIPS

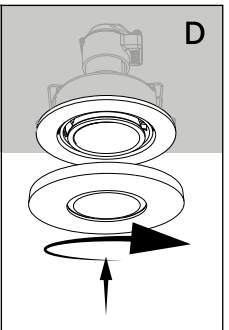
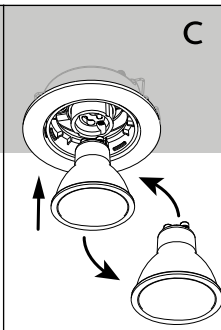
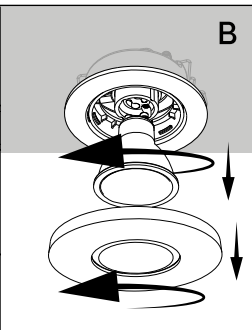
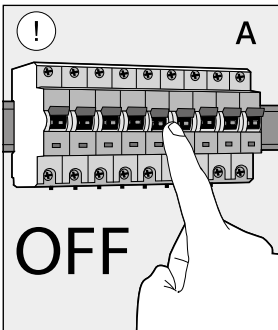
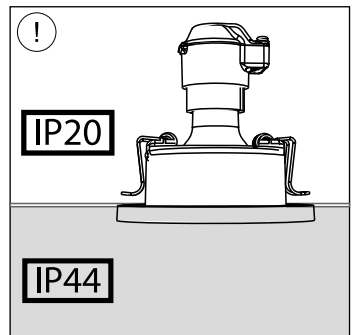
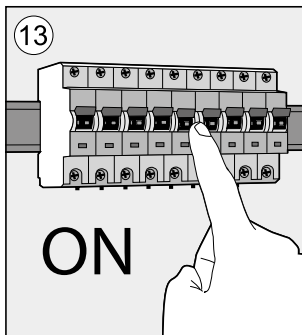
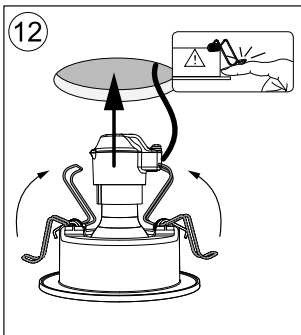
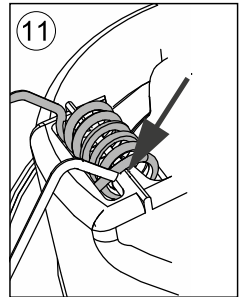
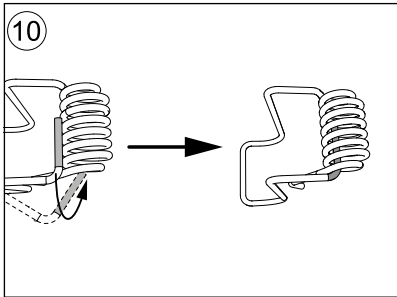
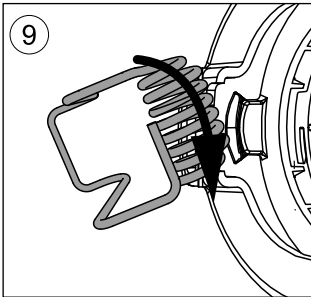
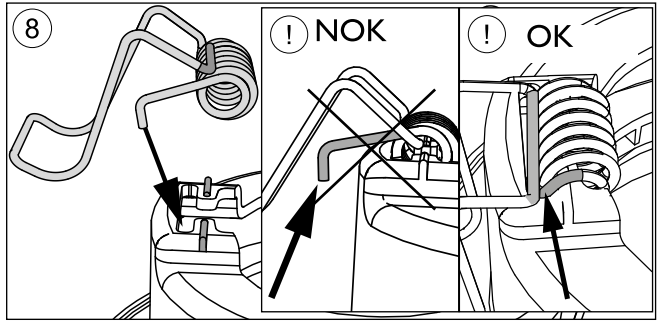
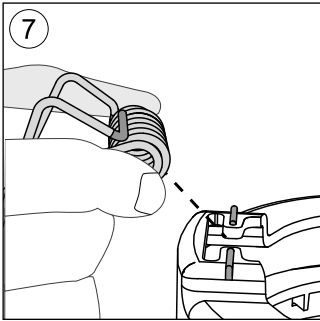

D